

P.O. Box 339
851 Harvard Avenue
Lindsay, California 93247

ADP
Quality Products by NDS

APRIL 2011 LIST PRICES

CATCH BASINS

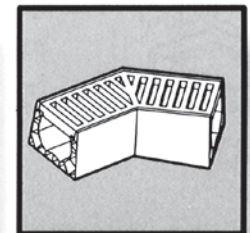
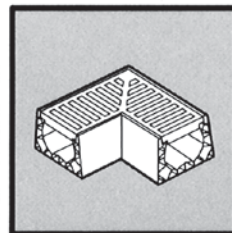
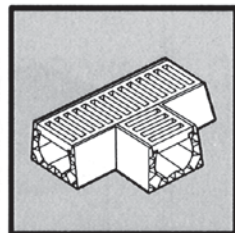
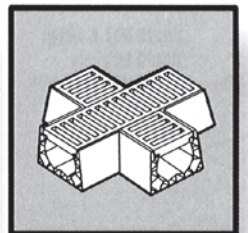
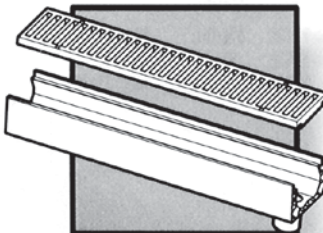
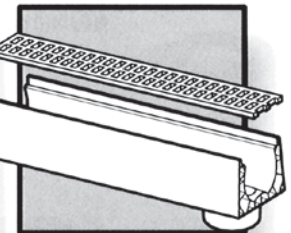
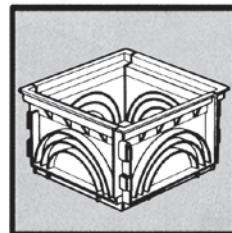
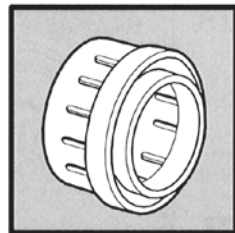
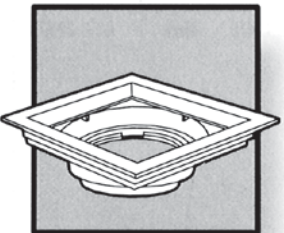
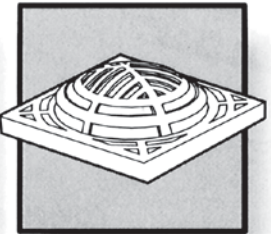
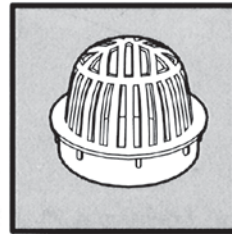
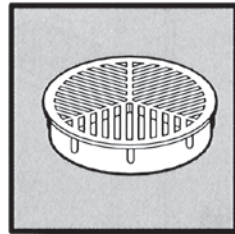
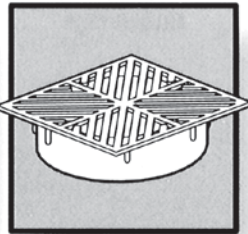
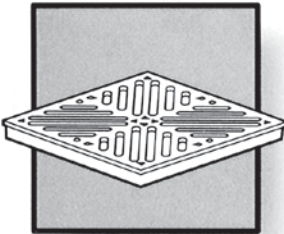
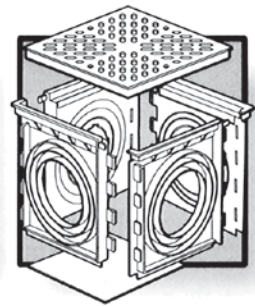
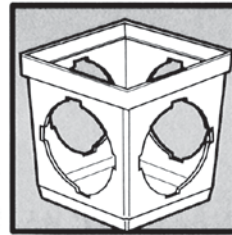
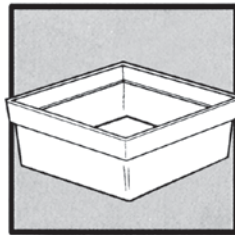
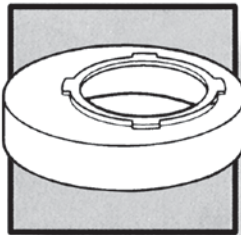
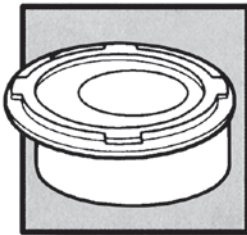

To place an order call 800-726-1994, send a fax to 800-726-1998, or visit ndspro.net



Over 30 years ago, NDS began producing plastic drainage and landscape products. From the beginning, our commitment to quality and innovation has been unwavering, leading to remarkable state-of-the-art products that fit every environment, every schedule, every need.

Today, our commitment to providing one-source solutions has led to the development of superior quality drainage products, landscape products, fittings, valve and meter boxes, and drip and micro irrigation products. No product is added to our line without meeting exhaustive testing and extensive research requirements. Plus, NDS is uniquely able to offer our complete inventory of products from regional warehouses in the US. Our goal: one-business-day delivery. Our track record: outstanding.

Take a moment to look through our catalog. If you have any questions contact Customer Service at 1-800-726-1994 from 5 a.m. to 5 p.m. PST. and let us offer the best solution for you.

To place an order, call 1-800-726-1994 from 5 a.m. to 5 p.m. PST.
To order online at any time, 24/7 visit: ndspro.net.



Square Grates

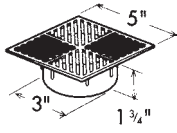

5-INCH SQUARE GRATE

Open Surface Area:
14.5 SQ. IN.
Fits 3" S&D Pipe and Fittings, 3" Corrugated Pipe and 3" Triple Wall Pipe; UV Stabilized

A-2205	Green	20	4	\$5.00
A-2305	Sand	20	4	\$5.00

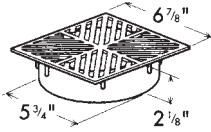

6-INCH SQUARE GRATE

Open Surface Area:
19 SQ. IN.
Fits 4" S&D Pipe and Fittings, 4" Corrugated Pipe and 4" Triple Wall Pipe; UV Stabilized

A-2106	Black	10	3.5	\$7.60
A-2206	Green	10	3.5	\$7.60
A-2406	Gray	10	3.5	\$7.60

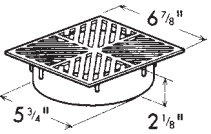

7-INCH SQUARE GRATE

Open Surface Area:
24 SQ. IN.
Fits 6" S&D Pipe and Fittings, 6" Corrugated Pipe and 6" Round Basins; UV Stabilized

A-2207	Green	10	5	\$11.53
--------	-------	----	---	---------

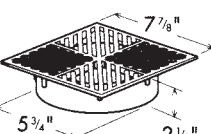

8-INCH SQUARE GRATE

Open Surface Area:
33.75 SQ. IN.
Fits 6" S&D Pipe and Fittings, 6" Corrugated Pipe and 6" Round Basins; UV Stabilized

A-2208	Green	8	5	\$12.01
--------	-------	---	---	---------

Round Grates

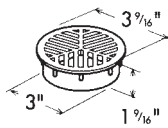

3-INCH ROUND GRATE

Open Surface Area:
2.6 SQ. IN.
Fits 3" S&D Pipe and Fittings, 3" Corrugated Pipe and 3" Triple Wall Pipe; UV Stabilized

A-3103	Black	30	4	\$3.63
A-3203	Green	30	4	\$3.63
A-3303	Sand	30	4	\$3.63
A-3403	Gray	30	4	\$3.63

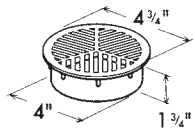

4-INCH ROUND GRATE

Open Surface Area:
4.16 SQ. IN.
Fits 4" S&D Pipe and Fittings, 4" Corrugated Pipe and 4" Triple Wall Pipe; UV Stabilized

A-3104	Black	20	3.5	\$3.85
A-3204	Green	20	3.5	\$3.85
A-3304	Sand	20	3.5	\$3.85

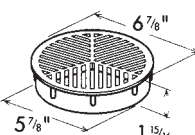

6-INCH ROUND GRATE

Open Surface Area:
10 SQ. IN.
Fits 6" S&D Pipe and Fittings, 6" Corrugated Pipe and 6" Round Basins; UV stabilized

A-3106	Black	20	9.5	\$10.79
A-3206	Green	20	9.5	\$10.79
A-3306	Sand	20	9.5	\$10.79
A-3406	Gray	20	9.5	\$10.79

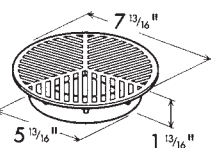

8-INCH ROUND GRATE

Open Surface Area:
23 SQ. IN.
Fits 6" S&D Pipe and Fittings, 6" Corrugated Pipe and 6" Round Basins; UV stabilized

A-3108	Black	10	7	\$12.58
A-3208	Green	10	7	\$12.58

Atrium Grates

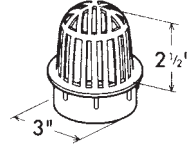

3-INCH ATRIUM GRATE

Open Surface Area:
10 SQ. IN.
Fits 3" S&D Pipe and Fittings, 3" Corrugated Pipe and 3" Triple Wall Pipe; UV Stabilized

A-4103	Black	40	6	\$8.53
A-4203	Green	40	6	\$8.53
A-4303	Sand	40	6	\$8.53

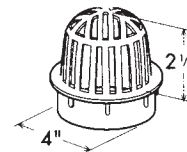

4-INCH ATRIUM GRATE

Open Surface Area:
14.5 SQ. IN.
Fits 4" S&D Pipe and Fittings, 4" Corrugated Pipe and 4" Triple Wall Pipe; UV Stabilized

A-4104	Black	20	4.5	\$12.85
A-4204	Green	20	4.5	\$12.85
A-4304	Sand	20	4.5	\$12.85

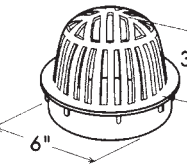

6-INCH ATRIUM GRATE

Open Surface Area:
29 SQ. IN.
Fits 6" S&D Pipe and Fittings, 6" Corrugated Pipe and 6" Round Basins; UV Stabilized

A-4106	Black	10	6.5	\$17.23
A-4206	Green	10	6.5	\$17.23

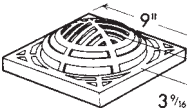

9" X 9" ATRIUM

Open Surface Area:
56.5 SQ. IN.
Fits 9" Square Catch Basin, 9" x 9" x 6" Extension, and Low Profile Adapter; UV Stabilized

A-4109	Black	4	3.5	\$39.03
A-4209	Green	4	3.5	\$39.03

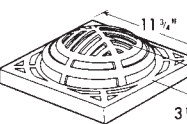

12" X 12" ATRIUM

Open Surface Area:
56.5 SQ. IN.
Fits 12" Square Catch Basin, 12" x 12" x 6" Extension and Low Profile Adapter; UV Stabilized

A-4112	Black	4	7.5	\$57.31
A-4212	Green	4	7.5	\$57.31

Note: All dimensions are nominal. All weights are for shipping purposes only. Prices (U.S. dollars) and availability are subject to change.

To place an order call 800-726-1994, send a fax to 800-726-1998, or visit ndspro.net

Product Class: 10AD	Description	Part No.	Color	Pkg. Qty.	Case Wt. (Lbs.)	List Price (Ea.)
---------------------	-------------	----------	-------	-----------	-----------------	------------------

6" Catch Basins

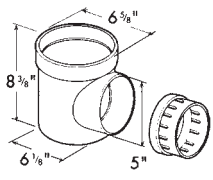

6" CATCH BASIN (ONE OUTLET)
(Universal Outlet Included) A-6061 Black 12 22 \$18.34

*Fits 3" & 4" Corrugated, S&D Pipe and 4" S&D Fittings
Fits 4" Corrugated Pipe without Universal Outlet for Full Flow*

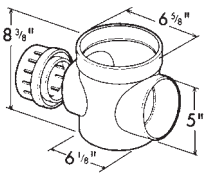

6" CATCH BASIN (TWO OUTLETS)
(Universal Outlet Included) A-6062 Black 10 22 \$18.34

*Fits 3" & 4" Corrugated, S&D Pipe and 4" S&D Fittings
Fits 4" Corrugated Pipe without Universal Outlet for Full Flow*

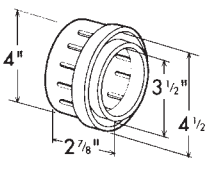

UNIVERSAL OUTLET INSERT
A-6306 Black 16 4 \$2.87
Fits 3" & 4" Corrugated, S&D Pipe and 4" S&D Fittings

9" x 9" Catch Basins

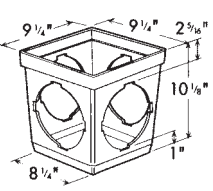

9" X 9" CATCH BASIN
Two Outlets A-6092 Black 4 9.5 \$26.20
Four Outlets A-6094 Black 4 7.5 \$28.87

*Use with Hub Outlets
Bottom Scribe Knockout*

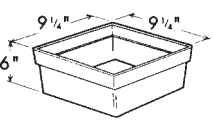

9" X 9" - 6" EXTENSION
6" Extension for A-6096 Black 4 9 \$25.47
9" x 9" Basin

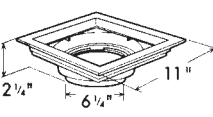

9" X 9" LOW PROFILE ADAPTER
A-6097 Black 6 6.5 \$23.55

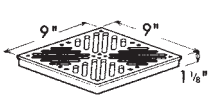

9" X 9" GRATE
Open Surface Area: A-2109 Black 8 9 \$33.82
23.75 SQ. IN. A-2209 Green 8 9 \$33.82

*Fits Square Catch Basin,
6" Extension and Low
Profile Adapter;
UV Stabilized*

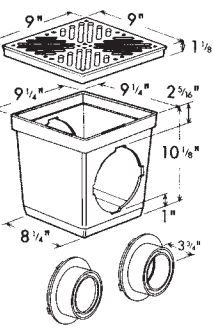

9" CATCH BASIN KIT
Open Surface Area: ADP9GKIT Green 4 14 \$68.98
23.75 SQ. IN.
Kit with Black Grate
*Kit includes 9" x 9"
Catch Basin, Square Grate,
3" & 4" Universal Outlet,
Plug and Grate Screws;
Grate is UV Stabilized*

Product Class: 10AD	Description	Part No.	Color	Pkg. Qty.	Case Wt. (Lbs.)	List Price (Ea.)
---------------------	-------------	----------	-------	-----------	-----------------	------------------

12" x 12" Catch Basins

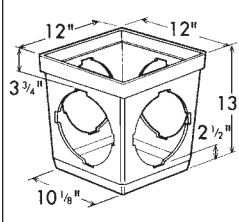

12" X 12" CATCH BASIN
Two Outlets A-6122 Black 4 17 \$44.73
Four Outlets A-6124 Black 4 16 \$60.60

*Use with Hub Outlets
Bottom Scribe Knockout*

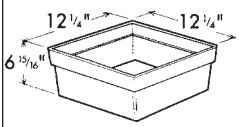

12" X 12" - 6" EXTENSION
For 12" x 12" Basin A-6126 Black 6 15 \$26.17

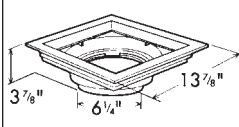

12" X 12" - LOW PROFILE ADAPTER
Use with Hub Outlets A-6127 Black 6 12 \$31.49

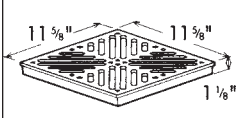

12" X 12" GRATE
Open Surface Area: A-2112 Black 8 19.5 \$50.23
49.5 SQ. IN. A-2212 Green 8 19.5 \$50.23

*Fits Square Catch Basin,
12" Extension and Low
Profile Adapter;
UV Stabilized*

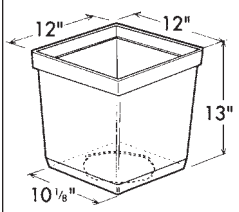

12" X 12" SUMP BOX
A-6120 Black 4 19.5 \$51.14

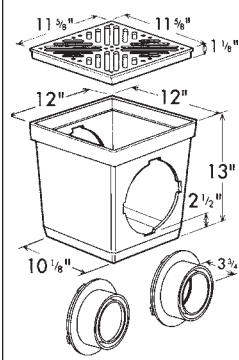

12" CATCH BASIN KIT
Open Surface Area: ADP12BKIT Black 4 27 \$98.23
49.5 SQ. IN. ADP12GKIT Green 4 27 \$98.23
Kit with Black Grate
Kit with Green Grate

*Kit includes 12" x 12"
Catch Basin, Square Grate,
3" & 4" Universal Outlet,
Plug and Grate Screws;
Grate is UV stabilized*

Note: All dimensions are nominal. All weights are for shipping purposes only. Prices (U.S. dollars) and availability are subject to change.

To place an order call 800-726-1994, send a fax to 800-726-1998, or visit ndspro.net

18" x 18" Catch Basins

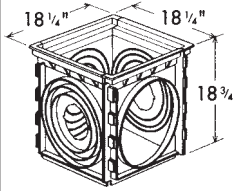

18" X 18" X 18" CATCH BASIN

Two Outlets A-6182 Black 1 17.5 \$220.72

Uses 4", 6" and 8" Outlets with Knockouts for 10" and 12" Outlets

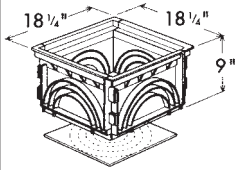

18" X 18" - 9" EXTENSION (NO BOTTOM)

Product Class 25AD A-6189 Black 2 15 \$114.02

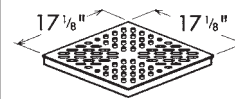

18" X 18" GRATE

Open Surface Area: 90.5 SQ. IN.
 Fits 18" x 18" Catch Basin and Extension
 A-2118 Black 4 25 \$184.54
 A-2218 Green 4 25 \$184.54

Hub Outlets & Plug

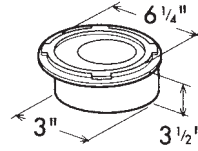

3" & 4" HUB OUTLET

Fits 3" & 4" S&D and Corrugated Pipe A-6044 Black 20 12.5 \$6.64
 (Use A-6306 for 3" S&D Pipe)

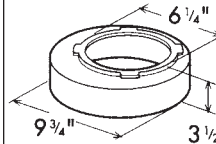

6" HUB OUTLET

Fits 6" S&D and Corrugated Pipe A-6066 Black 16 10.5 \$7.96

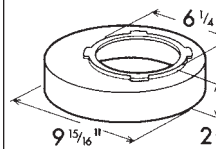

8" HUB OUTLET

Fits 8" S&D and Corrugated Pipe A-6088 Black 10 9.0 \$17.59

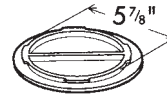

PLUG

Fits 9", 12" & 18" Basins A-6000 Black 20 6.5 \$5.28



Note: All dimensions are nominal. All weights are for shipping purposes only. Prices (U.S. dollars) and availability are subject to change.

To place an order call 800-726-1994, send a fax to 800-726-1998, or visit ndspro.net

2" Wide Channel Drains, Grates & Accessories

2" WIDE CHANNEL GRATES

Open Surface Area: 14.7 SQ. IN.

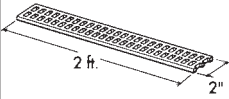

2" x 2 ft. Grate	A-8612	Black	8	10	\$19.74
2" x 2 ft. Grate	A-8632	Sand	20	10	\$19.74
2" x 2 ft. Grate	A-8642	Gray	20	10	\$19.74
2" x 2 ft. Grate	A-8652	Brick	20	10	\$19.74
Stainless Steel Screws No. 4 x 1/2"	A-7600	Steel	100/bag		\$54.40



2" WIDE CHANNEL END CAP

A-7624	Gray	20	1.5	\$7.72
--------	------	----	-----	--------



2" WIDE CHANNEL COUPLING

A-7634	Gray	20	1.5	\$8.02
--------	------	----	-----	--------



2" WIDE CHANNEL END OUTLET

Fits 2" Sch. 40 Fittings	A-7644	Gray	20	1.5	\$9.06
--------------------------	--------	------	----	-----	--------



2" WIDE CHANNEL SUPPORT BRACKET

A-7654	Gray	20	1.5	\$6.00
--------	------	----	-----	--------

4" Wide Channel Drains, Grates & Accessories

4" WIDE CHANNEL GRATES

Open Surface Area: 41.5 SQ. IN.

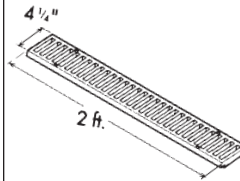

4" x 2 ft. Grate	A-8104	Black	8	13	\$32.99
4" x 2 ft. Grate	A-8204	Green	8	13	\$32.99
4" x 2 ft. Grate	A-8304	Sand	8	13	\$32.99
4" x 2 ft. Grate	A-8404	Gray	8	13	\$32.99
Stainless Steel Screws No. 8 x 1"	A-7400	Steel	12/bag		\$5.81

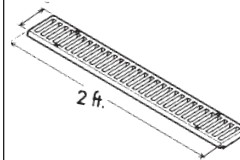

4" WIDE OVERLAPPING CHANNEL GRATE

Open Surface Area: 36.18 SQ. IN.

4" x 2 ft. Grate	8104	Black	8	13	\$32.99
4" x 2 ft. Grate	8204	Green	8	13	\$32.99
4" x 2 ft. Grate	8304	Sand	8	13	\$32.99
4" x 2 ft. Grate	8404	Gray	8	13	\$32.99
4" x 2 ft. Grate	8504	Brick	8	13	\$32.99



4" WIDE CHANNEL END CAP

A-7422	Gray	24	5	\$8.09
--------	------	----	---	--------



4" WIDE CHANNEL COUPLING

A-7424	Gray	24	1.5	\$8.09
--------	------	----	-----	--------



4" WIDE CHANNEL END OUTLET

3" S&D Spigot Outlet	A-7423	Gray	24	6	\$9.36
2" Sch. 40 Spigot Outlet	A-7426	Gray	24		\$9.36



4" WIDE CHANNEL SUPPORT BRACKET

A-7425	Gray	24	3.5	\$4.81
--------	------	----	-----	--------

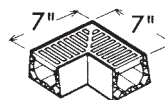

4" WIDE CHANNEL 1/4 BEND

90° Elbow	A-7452-4	Gray	1		\$49.66
-----------	----------	------	---	--	---------

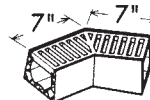

4" WIDE CHANNEL 1/8 BEND

45° Elbow	A-7455-4	Gray	1		\$58.97
-----------	----------	------	---	--	---------



Note: All dimensions are nominal. All weights are for shipping purposes only. Prices (U.S. dollars) and availability are subject to change.

To place an order call 800-726-1994, send a fax to 800-726-1998, or visit ndspro.net

Channel Drains Installation

1. Standard Installation

Excavate a trench to accommodate the channel and bedding concrete. Erect a string line at each end of the drain run as a guide for laying the channels to the required level. Begin channel installation at the evacuation or discharge end of the run where the outlet or outlets are located.

Install channel end-to-end PVC cementing sections together. Design bottom or end outlets into the channel run in the appropriate location and glue to the drain pipe or fittings. PVC cement end caps where appropriate.

Using either NDS stakes, 1/2" or 5/8" rebar or wood stakes, anchor channel to the trench bed every 24" on each side of channel. Backfill with either concrete, sand, or soil depending on the application. Pour slab to grade and finish concrete.

Figure 1A illustrates a light vehicular installation in which a concrete base may not be required. Compacted soil and a 1" sand base may be used in place of concrete.

Figure 1B illustrates a concrete base underneath the channel recommended for heavy load applications or freeze/thaw zones where heaving may be a problem.

2. Suspended Installation

Suspended installation is ideal for retrofit installations with an existing concrete slab or new construction where forms can be used to suspend the channels. Prepare the trench excavation. Using 2" x 4" boards span the width of the trench and bolt the channel grates to the boards. Pour and compact concrete under and around the channels. Finish to the proper grade. Figure 2 illustrates this installation.

3. Slurry Installation

This installation may be used in lieu of the standard installation. Prepare the trench excavation and pull a stringline to the proper elevation. Pour a slurry of concrete in the trench to a depth that will insure at least 4" of concrete underneath the channels. Lay the channels in the bedding slurry. Check the channel alignment and grade again. After the slurry sets, concrete can be poured around the channel and finished to the proper grade. Figure 3 illustrates this installation.

Important Installation Notes:

1. Refer to load classification chart for proper application.
2. PVC primer and medium body fast set PVC solvent cement must be used to cement all components.
3. Grate must be installed prior to pouring concrete or backfill.
4. Grates should be taped prior to pouring concrete to prevent debris from entering channel during installation.
5. **Grate should be recessed 1/8" below finish grade in non traffic applications. Grate should be recessed 1/4" in traffic applications.**
6. In asphalt or hot mastic applications, the channels must be encased in concrete for strength and to prevent distortion of the channel.
7. Expansion joints must be provided parallel, but not immediately adjacent to each side of the drain run. Crack control joints may be utilized at right angles to the channel for installation in concrete.
8. Grate must be installed and screwed down on channel at all times except for cleaning.

Mini and Spee-D Channel Only

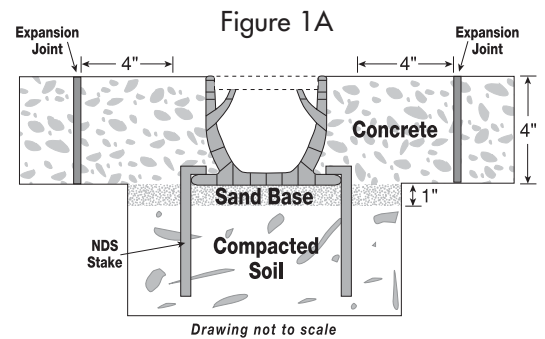

Mini, Spee-D and Pro Series Channel

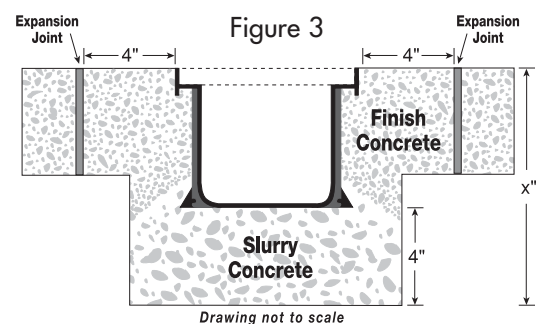
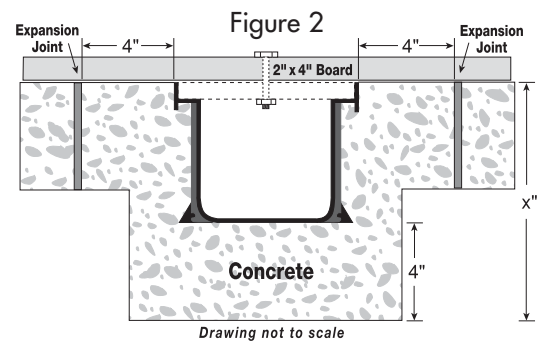
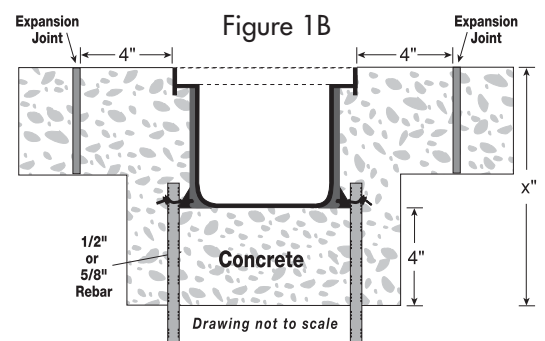

TERMS AND CONDITIONS OF SALE

Terms: Standard terms are 2% NET 10 days. A 1 1/2% per month (18% per annum) service charge will be added to all past due accounts. All invoices are to be paid in US Currency. Title and risk of loss pass to buyer upon shipment.

Freight Allowance: Freight prepaid on orders of \$1000.00 NET or more, with the exception of shipments to HI, AK, and PR for which freight is prepaid on orders of \$2500.00 NET or more. Prepaid freight levels are based on shipments to one location only. It is the responsibility of the customer to determine if his purchase order meets the minimum freight allowance required. NDS reserves the right to select the carrier and point of shipment.

Canadian Orders: Freight prepaid on orders of \$1,500.00 (US\$) NET or more. Custom DuraCast only orders freight prepaid on orders of \$2500.00 (US\$) NET or more.

The above freight policies apply to the continental US and Canada only. For other areas please contact NDS.

Errors & Claims: All claims for shortage in shipment or damaged material must be noted on the "Bill of Lading" and a written request for credit submitted to NDS within 15 days of shipment. NDS responsibility ceases upon delivery to the carrier.

Returned Goods: Returned goods will be accepted only after written approval and shipping instructions are received from NDS. A return goods authorization number is required and must be on all cartons, documents, and correspondence. All returns are subject to a 25% restocking charge, freight cost of returned goods (plus "out freight if applicable"). A higher restocking charge may be assessed against any return requiring extraordinary handling costs.

Minimum Order: \$100.00 minimum order net billing. A 15% broken box charge will be added for other than full box quantities.

Limited One Year Warranty: The liabilities of NDS are limited solely and exclusively to replacement as set forth in our standard "Statement of Warranty", alone and do not include any liability for incidental, consequential or other damage of any kind whatsoever, whether any claim is based upon theories of contract, warranty, negligence or tort and without any limitations and do not include shipping charges, labor, installation or any other losses or expenses incurred in operation of any replacement specialty item or fitting. NDS drainage products are designed to be used for exterior surface drainage only.

Limited Lifetime Warranty: NDS warrants to the original owner of its NDS catch basins, grates, channel and Pro Series valve boxes, subject to the conditions set forth in this warranty, that NDS catch basins, grates, channel and Pro Series valve boxes will remain free from manufacturing defects.

All NDS products are guaranteed against defects resulting from faulty workmanship or materials. Claims for labor costs and other expenses required to replace defective products or repair of any damage resulting from the use thereof will not be allowed by NDS. Our liability is limited to replacement of products acknowledged by NDS to be defective.

Exclusive Warranties and Remedies: The foregoing remedies are exclusive and are given and accepted in lieu of (i) any and all other warranties, express or implied, including without limitation the implied warranties of merchantability and fitness for particular purpose; and (ii) any obligation, liability, right, claim or remedy in contract or tort, whether or not arising from NDS, Inc.'s negligence, actual or imputed. The remedies of customer shall be limited to those provided herein to the exclusion of any and all other remedies including, without limitation, incidental or consequential damages. No agreement varying or extending the foregoing warranties or these limitations will be binding on NDS, Inc., unless such is signed in writing by an authorized officer of NDS, Inc.

The liability of NDS, Inc., hereunder shall be limited to restoring to good working order, provided that NDS, Inc., is not required to restore the product to good working order when such failure is due to causes beyond NDS, Inc.'s control, including but not limited to, acts of God, acts of civil or military authority, priorities, strikes, floods, epidemics, war, riots, and other causes that are beyond the manufacturers control.

These provisions are complete and exclusive statements of all terms and conditions between NDS, Inc., and the consumer. These provisions may not be varied, supplemented, qualified or interpreted by any prior course of dealings, written or oral or by trade usage. No NDS, Inc. agent, officer or employee has authority to make any representation, promise or warranty concerning these provisions.



- Catch Basins & Grates
 - Channel Drains
 - Dura Slope™ Pre-Sloped Trench Drain Systems
 - EZflow® Gravel Free French Drain
 - Flo-Well® Manufactured Dry Well
 - Flo Control™ Ball Valves
- Flo Control™ Check Valves
 - Flo Control™ Transition, Compression & Repair Fittings
 - Backwater & Diverter Valves
 - Sewer & Drain Fittings
 - Permeable Pavers
 - Root Barriers
- Valve Boxes
 - Meter Boxes
 - Flexible Couplings
 - Flexible Saddles
 - Agrifim™ Drip Irrigation

PARTIAL CLIENT LIST

The White House
Los Angeles Country Club
Pebble Beach
Cypress Point
Spyglass Hill
PGA West Stadium Golf Course
Princeville Golf Course
Ritz Carlton
Santa Barbara Zoo
Sheraton Hotels

Sherwood Country Club
Soldier Field
Del Webb & Sun City Country Clubs
Westin Hotels
Riviera Country Club
Buchart Gardens
Disney World
Disneyland
Florida University
Harbortown Golf Links

Hyatt Grand Champions
La Quinta Resort
Marriott Hotels
MGM Grand Hotel & Theme Park
Mirage Hotel
Jack La Lane Athletic Clubs
Olympic Training Center

Regional Warehouses:

- Lynnwood, WA
- Mineola, TX
- Philadelphia, PA
- Powder Springs, GA
- Visalia, CA
- Fresno, CA

Address/Telephone
P.O. Box 339 • 851 N. Harvard Avenue
Lindsay, CA 93247
Phone: 800-726-1994
Fax: 800-726-1998
International Phone: 559-562-9888
International Fax: 559-562-4488
e-mail: nds@ndspro.com

www.ndspro.com

FOR TECHNICAL INFORMATION, CONTACT:

Technical Services
(888) 825-4716
TechService@ndspro.com